

Guía mecánica D6000

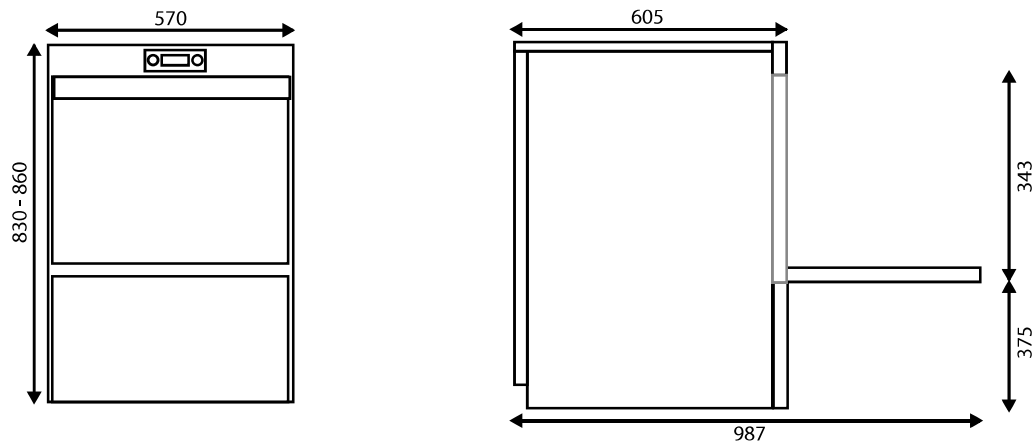

Electricidad

Voltaje	Intensidad max.	Amperaje	Fusible recomendado
230V 2~ TF	7.3 kW	22 Ampere	2 x 30 Ampere

Agua

Presión	Caudal	Calidad	Temperatura	Toma
1.0 - 6.0 bar	4 l/min	4° GH máximo	60°C máximo	3/4

Drenaje

Toma	Altura máxima
1 1/2" (40 mm)	60 cm

